

SOULÈVE-PERSONNE POUR PISCINE + SOCLE A

SOULÈVE-PERSONNE POUR PISCINE

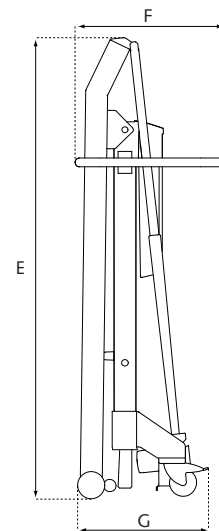
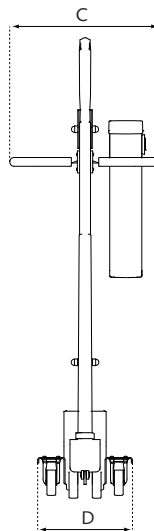
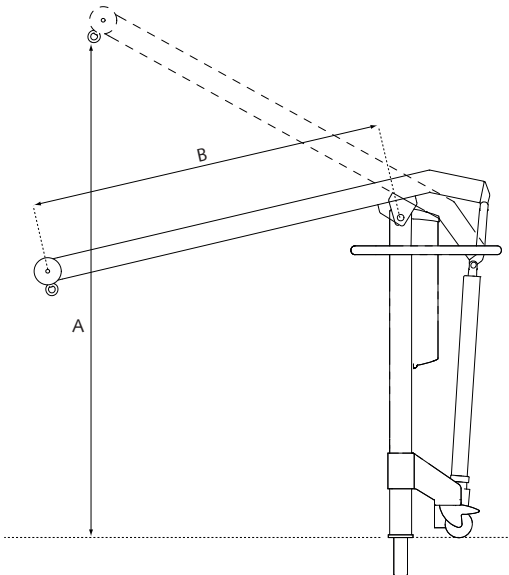

Dimensions (mm)

A	1840
B	1305
C	540
D	350
E	1700
F	550
G	500

capacité de levage max.	135 kg
batteries	2 x 12 Vdc; 6,5 - 7,2 Ah
chargeur	séparé

diamètre des roulettes	100 mm
construction	aluminium ; inox ; laqué
commande manuelle	électrique IP67

SOCLE A



Châssis-mains

S	ref. 1025
S polis par électrolyse (anti-corrosion)	ref. 1027

+ supports de cuisses antidérapants ref. 1080

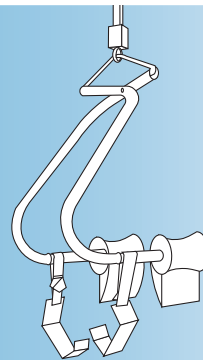

Sangle Standard avec appuie-tête en forme de lune et parties jambières ouatées

XS	ref. 3433
S	ref. 3430
M	ref. 3431
L	ref. 3432
XL	ref. 3434

+ Fléau ref. 2110 + 2111

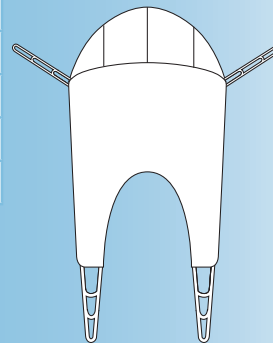
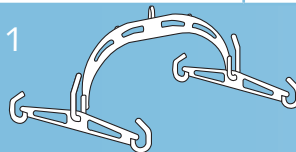

Siège de Bain (PVC)

Unisize	ref. 3473
---------	-----------

+ Fléau ref. 2110

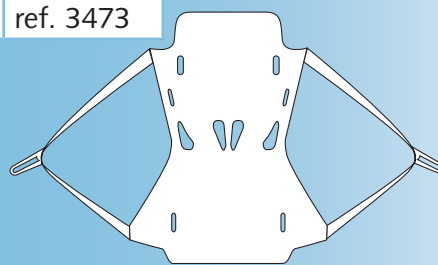
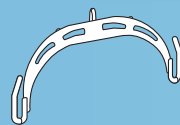

Sangle de Bain (PVC)

XS	ref. 3476
S	ref. 3463
M	ref. 3464
L	ref. 3465
XL	ref. 3477

+ Fléau ref. 2110

